

Hall-B Run Group H

CLAS12 Experiments with a Transversely Polarized Target

Meeting with INFN Referees, July 10 - 2024

PAC39 2012

Experiment	Contact	Title	Rating	PAC days
C12-11-111	M. Contalbrigo <i>INFN co-sp.</i>	Transverse spin effect in SIDIS at 11 GeV with a transversely polarized target using CLAS12	A	110
C12-12-009	H. Avakian <i>INFN co-sp.</i>	Measurement of transversity with di-hadron production in SIDIS with a transversely polarized target	A	110
C12-12-010	L. Elauadrhiri <i>INFN co-sp.</i>	Deeply Virtual Compton scattering at 11 GeV with transversely polarized target using the CLAS12 detector	A	110

C1 condition: “One has to achieve at least within a factor 2 the figure-of-merit determined by the target design value ($I=1$ nA, and 60% polarization) and a spin relaxation time of 50 days at 1 nA before the experiments with the transversally polarized target are approved”.

All RGH experiments selected among the high impact JLab measurements PAC42 [2014]

RGH experiment status confirmed at PAC48 in 2020 (during jeopardy process)

RGH under jeopardy process at PAC52 in 2024

Access to unique observables

Transversity (TMD)
Sivers, h_{1T}^{\perp} , g_{1T}^{\perp} , H_1^{\perp}

Transversity (coll)
Di-hadron FFs

GPD E

Gather unprecedented information on

Tensor charge

Quark orbital motion

$$ep \rightarrow e' h X$$

$$\langle P_{h\perp}^2 \rangle = z^2 \langle k_T^2 \rangle + \langle p_T^2 \rangle$$

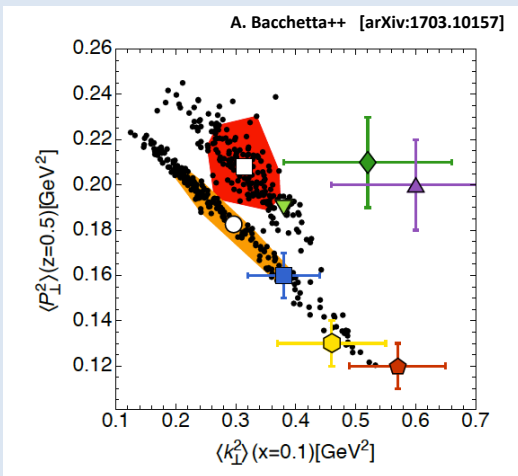
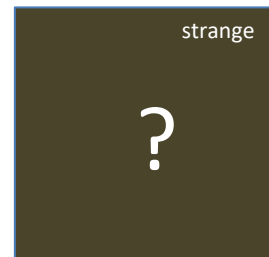
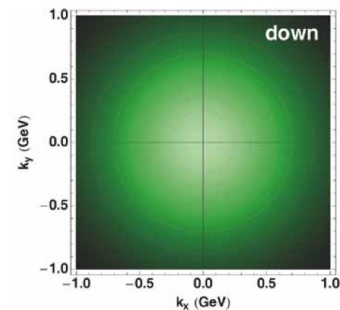
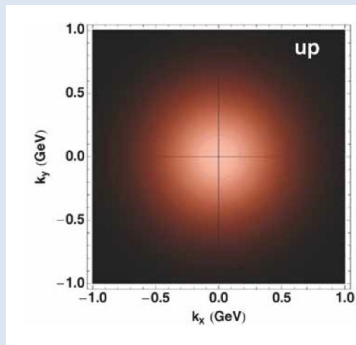
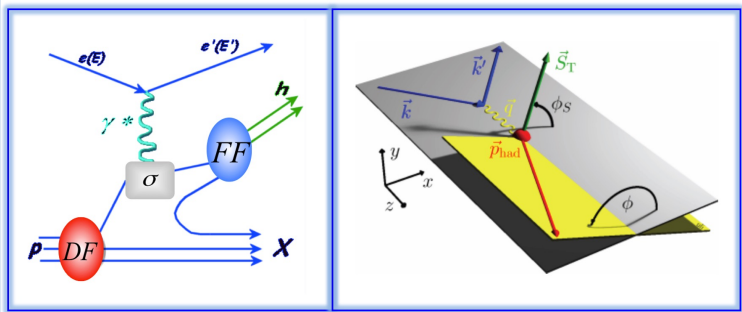

$m_W = 80370 \pm 7$ (stat.)
 ± 11 (exp. syst.)
 ± 14 (mod. syst.)
+9 / -6 (TMDs) MeV

A. Bacchetta++ [arXiv:1807.02101]

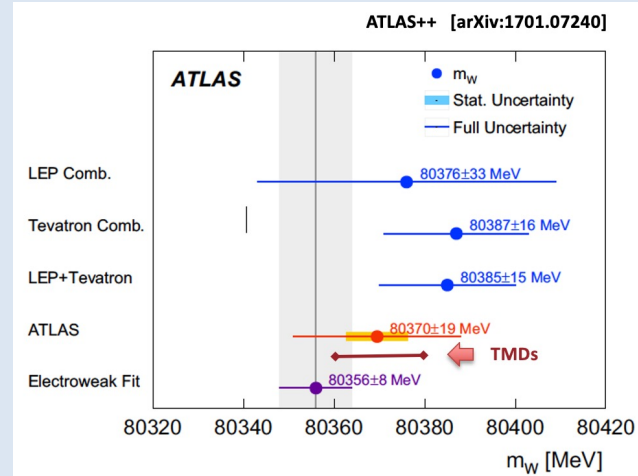

Quark distribution imbalance connected to orbital angular momentum and FSI

$$f_1(x, k_T^2; Q^2) - \frac{k_x}{M} f_{1T}^\perp(x, k_T^2; Q^2)$$

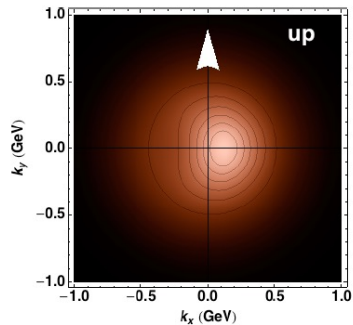
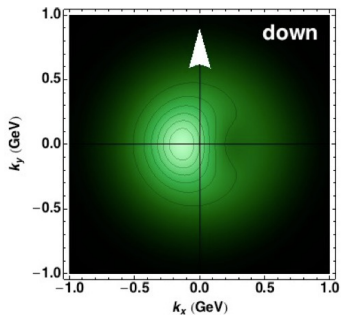

A. Bacchetta++ [arXiv: 2004.14278]

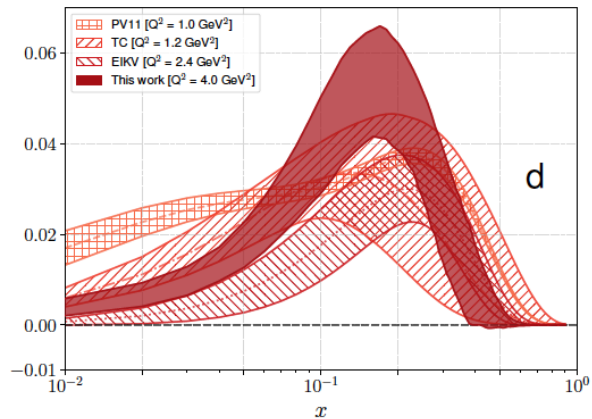
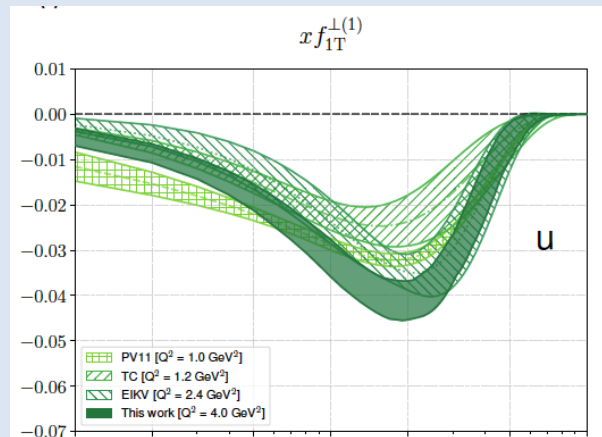

SIDIS

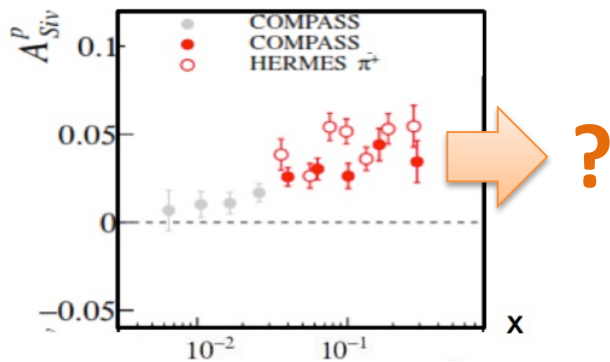

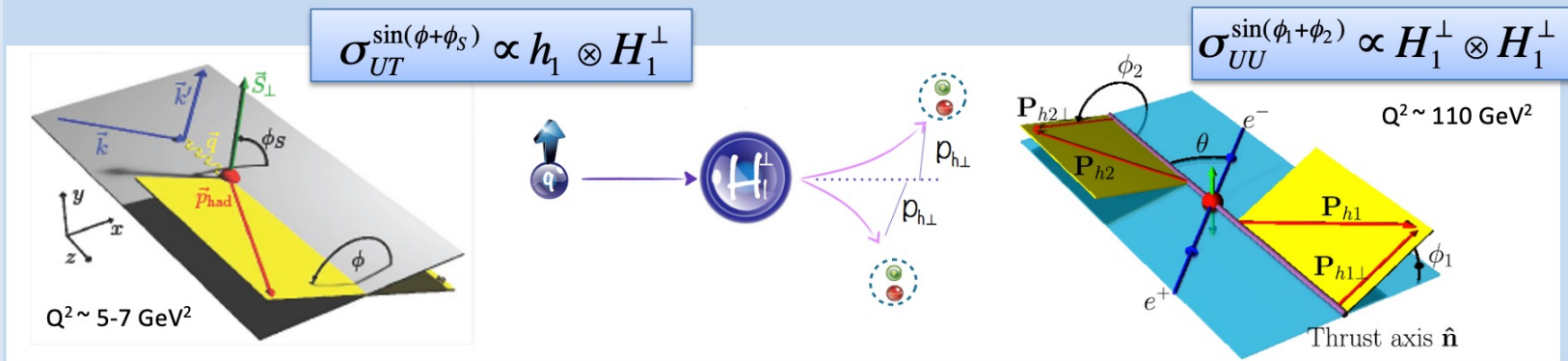

HERMES [arXiv 0408013]

COMPASS [arXiv 1005.5609]

BESIII [arXiv 1507.06824]

HERMES [arXiv 0906.3918]

COMPASS [arXiv 1408.4405]

Belle [talk at DIS2014]

Babar [arXiv 1309.5278]

SIDIS

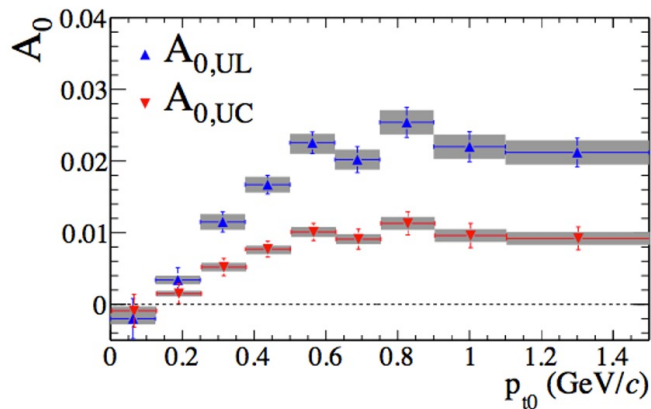
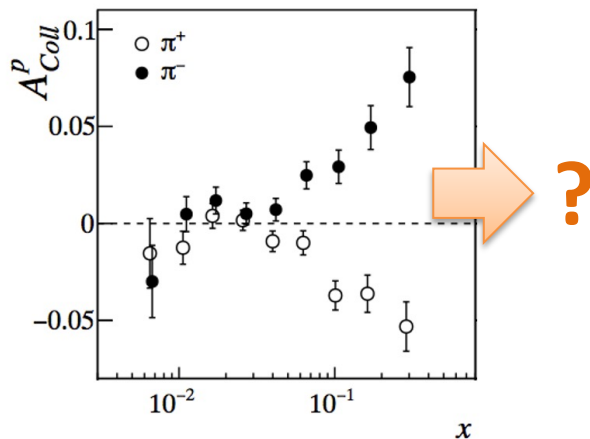

e^+e^-
Collision

Collins
(TMDs)

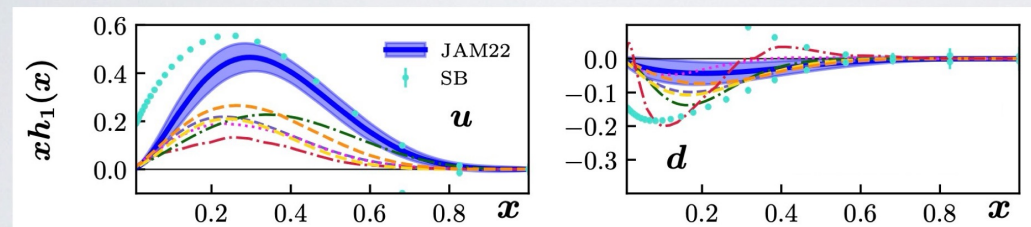
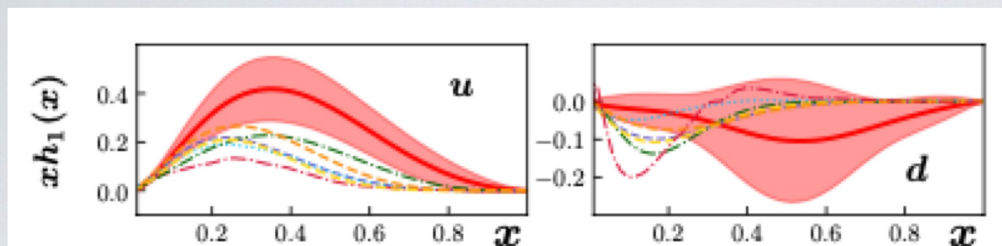

Soffer bound

JAM20	×
Anselmino 15	✓
Kang 16	✓
D'Alesio 20	✓
Radici 18	✓
Anselmino 13	✓
Benel 19	✓
JAM22	✓

$\leq \Delta f_1, \Delta g_1$

Di-hadron
(Collinear)

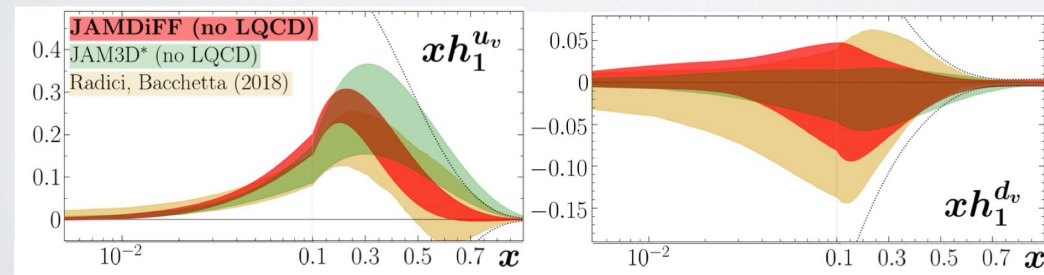

Anselmino 15	✓
Boglionne 24	✓
D'Alesio 20	✓

a posteriori

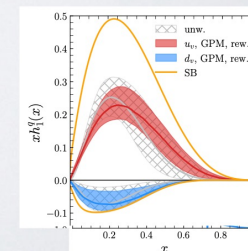

* JAM3D includes $\bar{u} = -\bar{d}$ w.r.t. JAM22

D. Pitonyak, QCD Evolution 24

Fundamental quantity connected with BSM physics: tensor coupling beyond V-A & EDM violating T and CP
 Growing interplay with lattice calculations

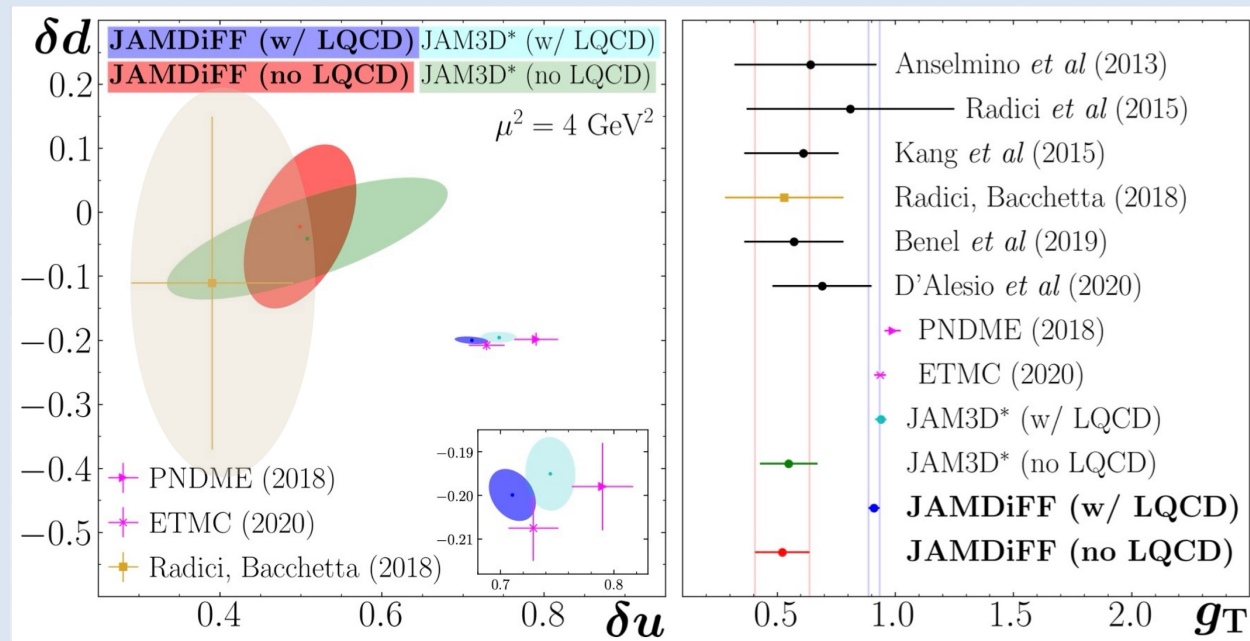
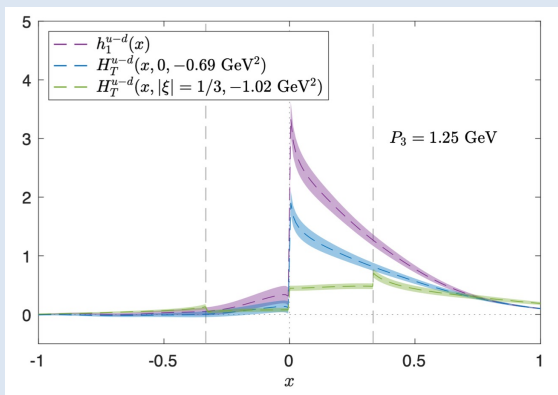
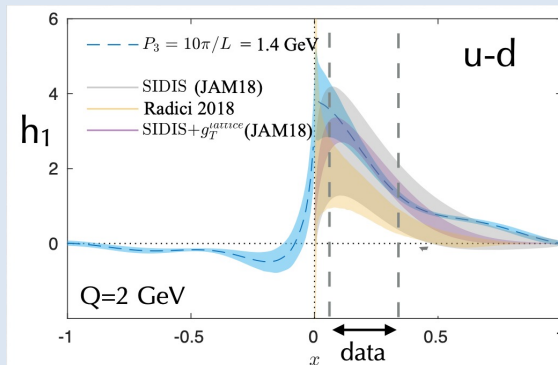

Adapted from D. Pitonyak @ QCD Evolution 24

$$\frac{d^4\sigma}{dQ^2 dx_B dt d\phi} \propto (|\mathcal{T}_{DVCS}|^2 + |\mathcal{T}_{BH}|^2 + \mathcal{I})$$

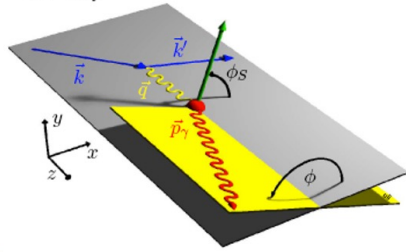

ep → e' γ p'

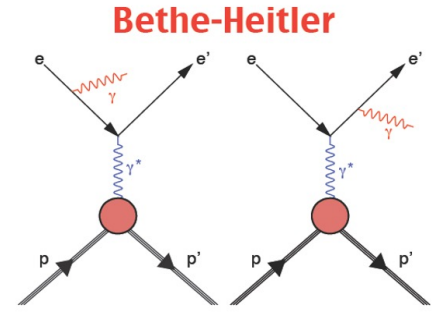
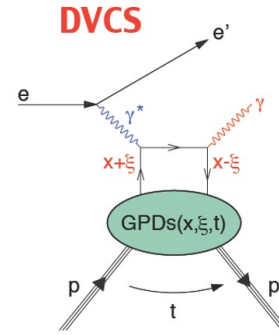

Information on the real and imaginary part of the QCD scattering amplitude

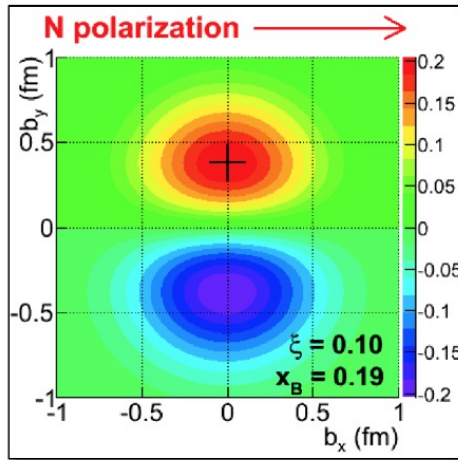

Access to elusive E_p GPD

OAM L_q = J_q - 1/2 ΔΣ via Ji sum rule

$$J_q = \lim_{t \rightarrow 0} \int_{-1}^1 dx x [H_q(x, \xi, t) + E_q(x, \xi, t)]$$

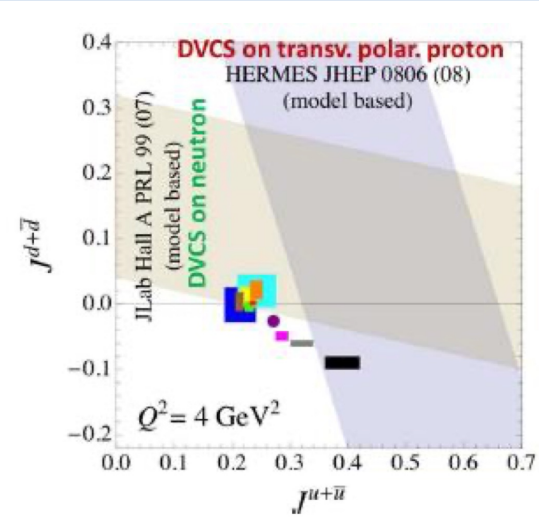

Large acceptance spectrometer. Operative since 02/18

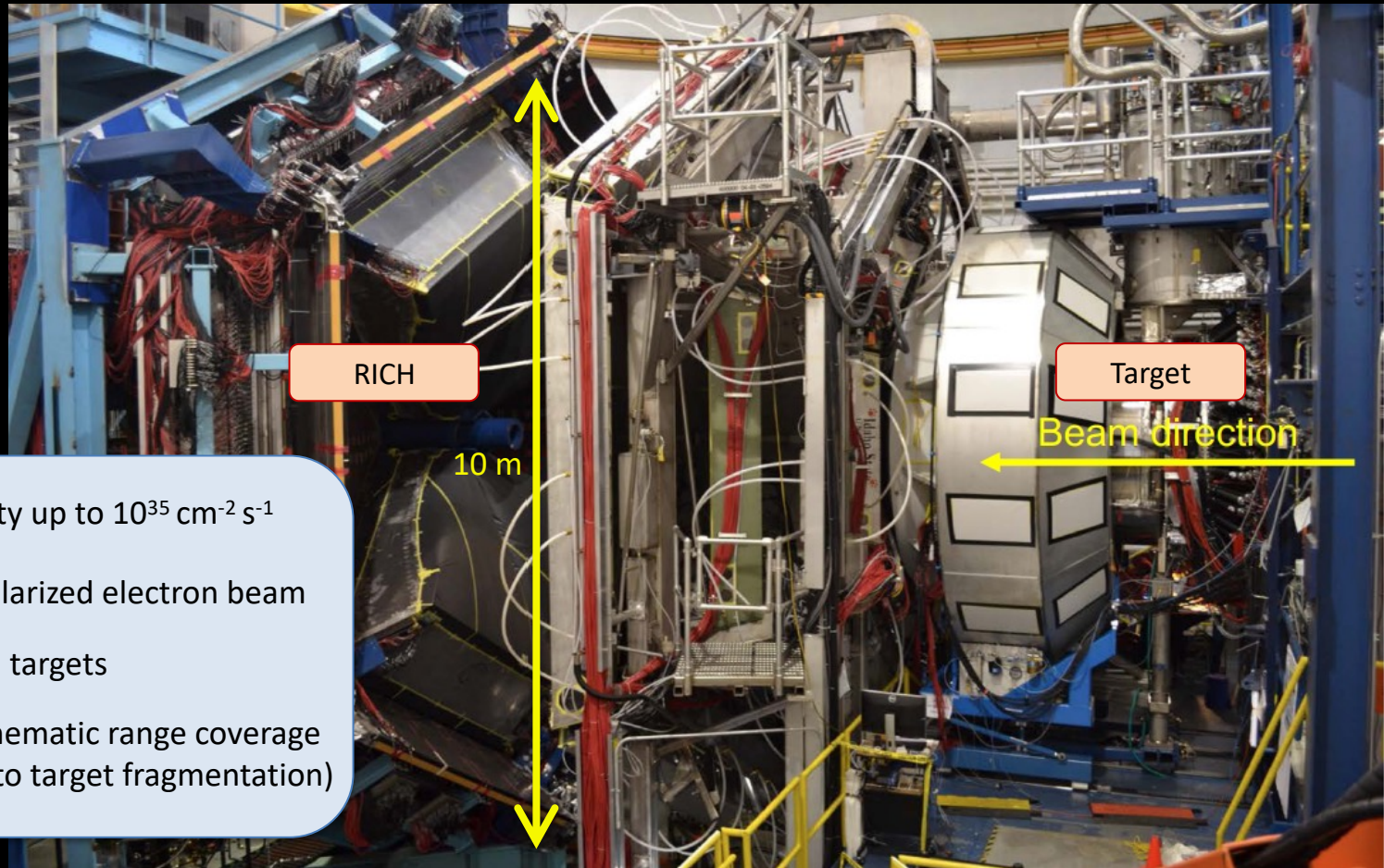

Luminosity up to $10^{35} \text{ cm}^{-2} \text{ s}^{-1}$

Highly polarized electron beam

Polarized targets

Broad kinematic range coverage
(current to target fragmentation)

Features: wide phase space cover, excellent PID and statistics optimized for a multi-D analysis

- disentangle kinematical correlations
- verify expected dependences (e.g. in Q^2) and isolate peculiar regimes (e.g. in z)
- study transition regions (e.g. in P_T)

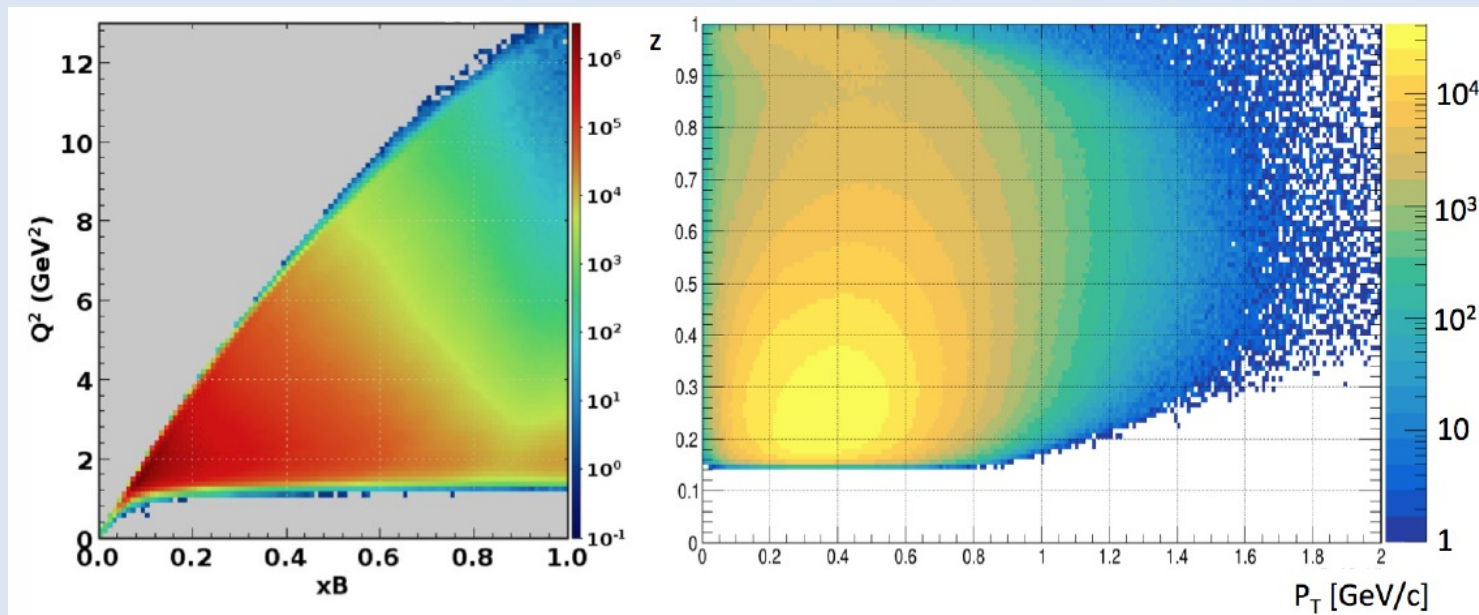

Multidimensional, high precision measurements of beam single spin asymmetries in semi-inclusive π^+ electroproduction off protons in the valence region

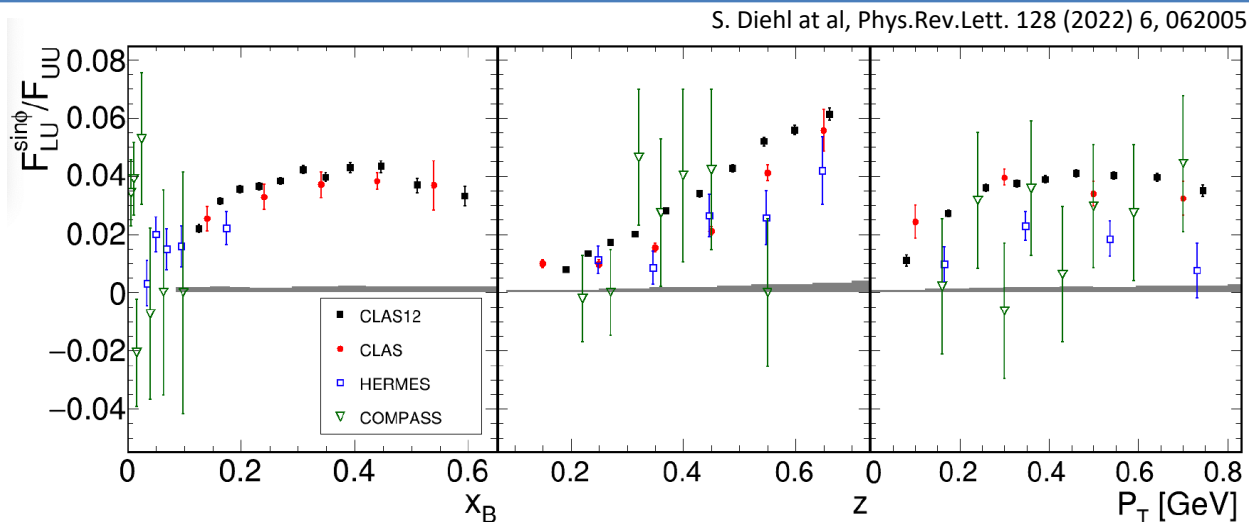

Sensitive to TMDs and the strong-force correlations within the nucleon

- With respect the past:
- extended range in the valence region well inside the DIS regime
 - superior statistics instrumental for multidimensional study
 - comparable wide coverage in z and P_T

Semi-inclusive physics with unprecedented coverage of valence & flavor sensitivity

Time-of-flight system

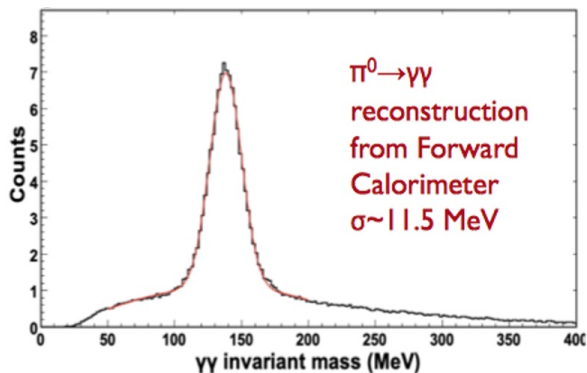
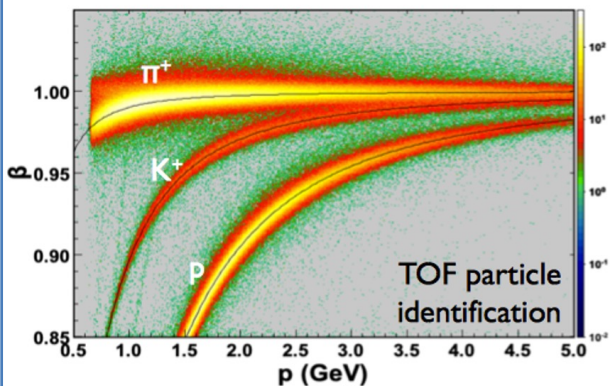

Ring-imaging Cherenkov (completed in 2022)

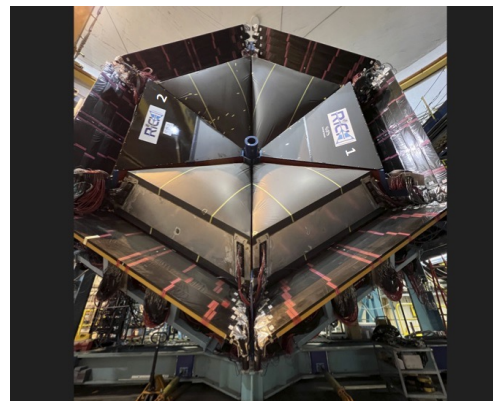

Cherenkov angle vs Momentum - All

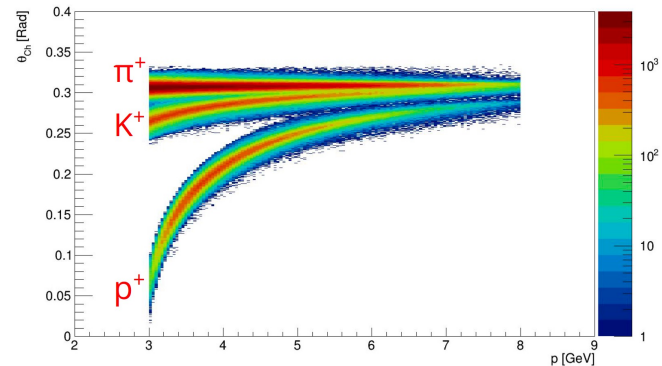

Pion correctly identified

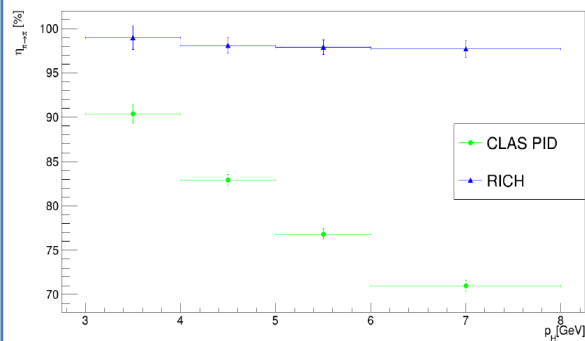

Pion misidentified as a kaon

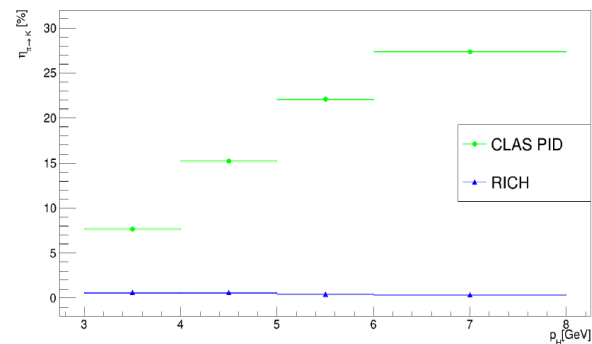

Natural choice for a frozen-spin target



MgB ₂	Conventional SC magnet
<ul style="list-style-type: none"> • Compact • Low material budget • No current leads but low-T cryostat • Moderate magnetic field (~ 1T) • External magnet 	<ul style="list-style-type: none"> • Massive • Current leads & external power • Conventional shape and cryostat • Strong magnetic field (~5 T) • 10⁻⁴ uniformity

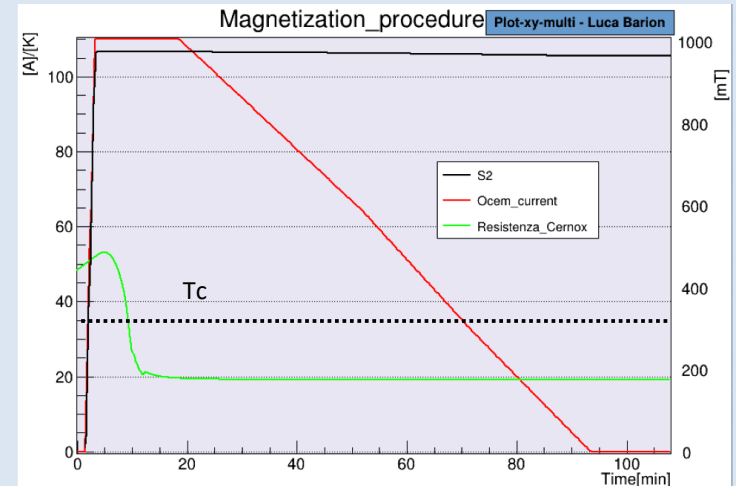
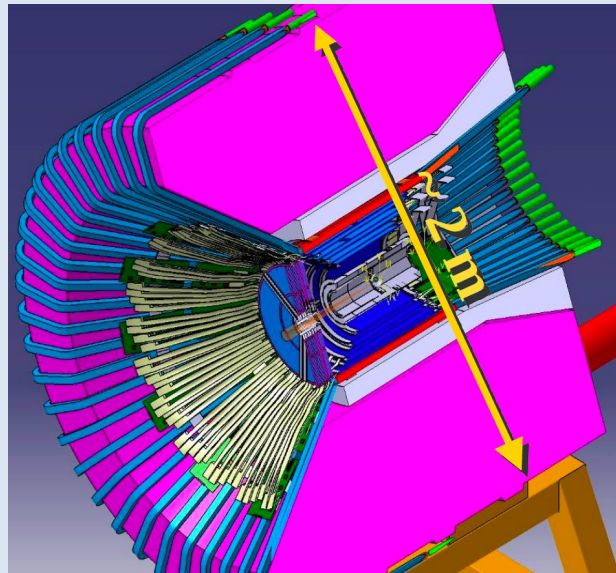

Initial instability solved by anchoring the sample

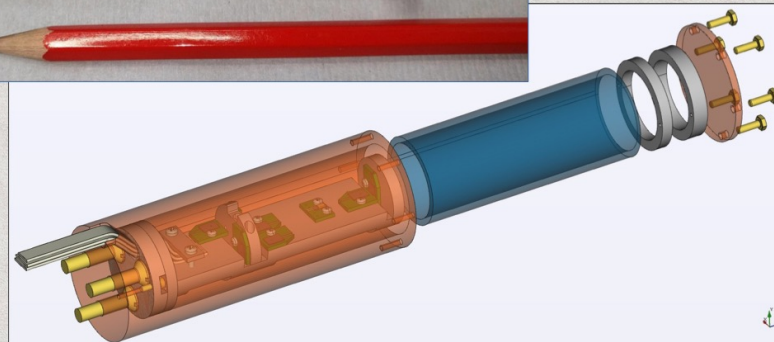
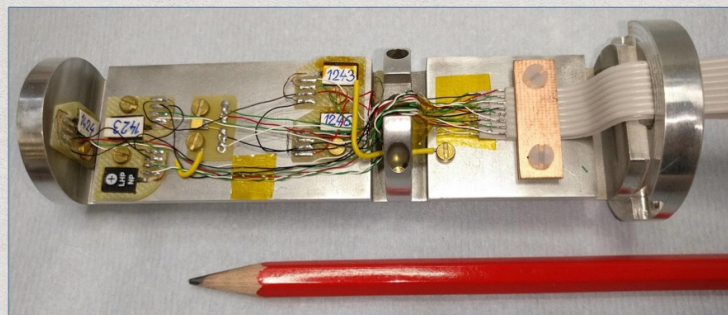
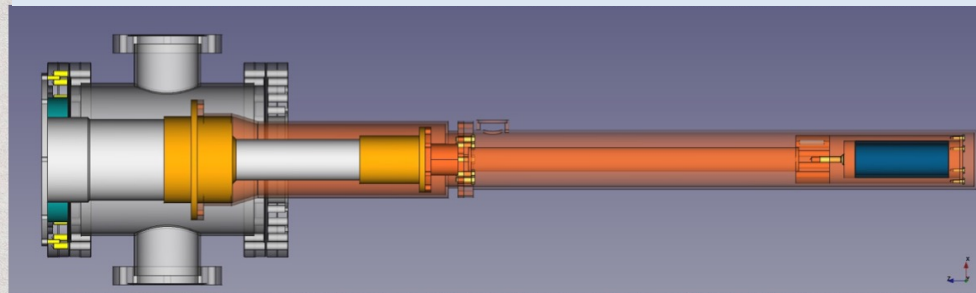
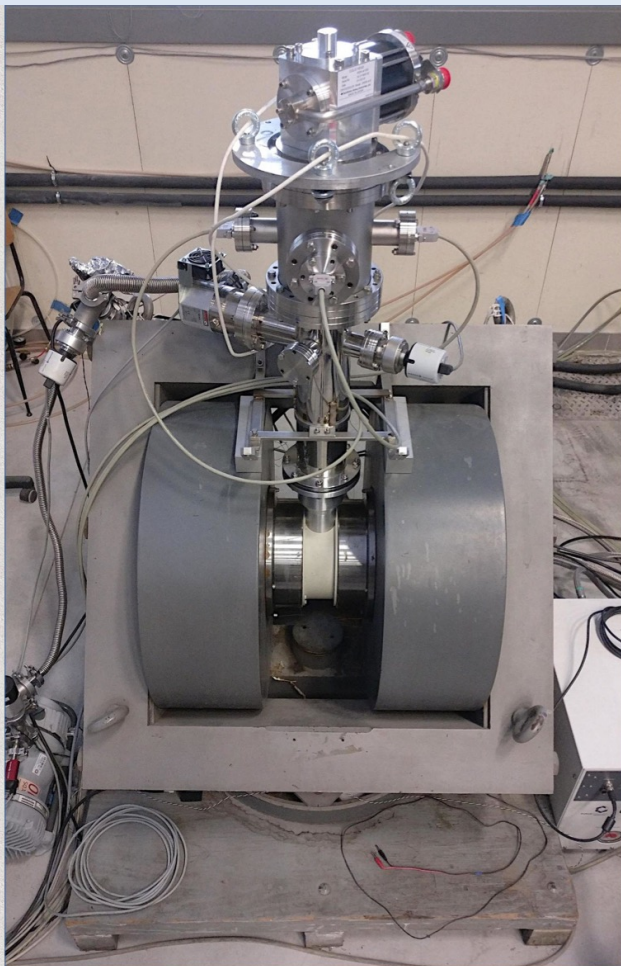

2024 campaign

Results on sample #6 P100

(from new set)

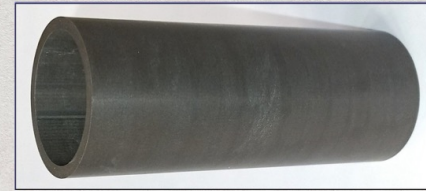

Best magnetization: 964 → 955 mT (**99%**)
[@ 16.5 K]

Best shielding: 5 → 16 (965) mT (**1%**)
[@ 18.0, 19.4, 21.4 K]

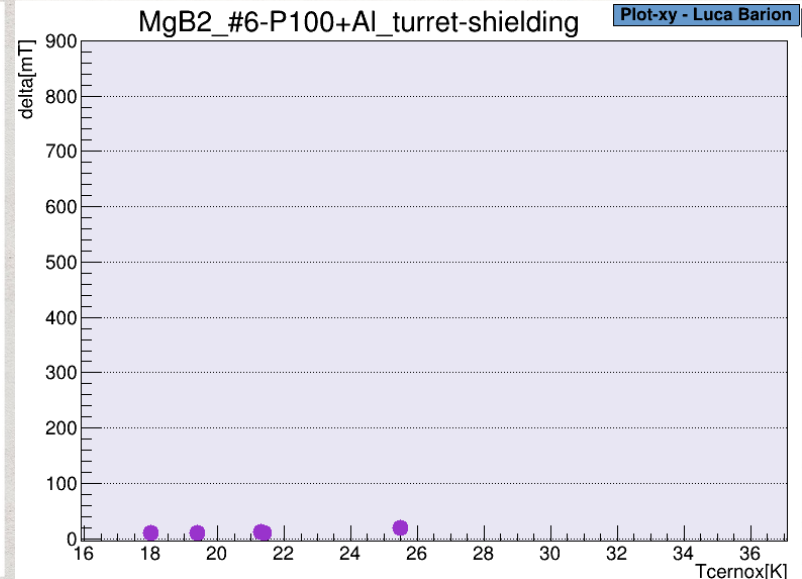
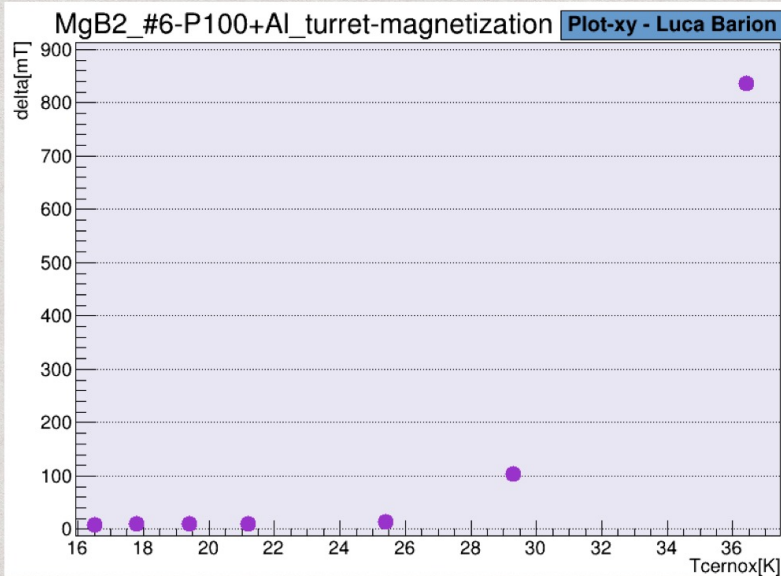

New results presented at the 6th Incontro Nazionale di Fisica Nucleare, Trento, 26-28 febbraio 2024
Characterization campaign ongoing at FE, propedeutical to the double-field measurement at LASA

2024 campaign

Long term performance

Magnetization, 2024-02-22

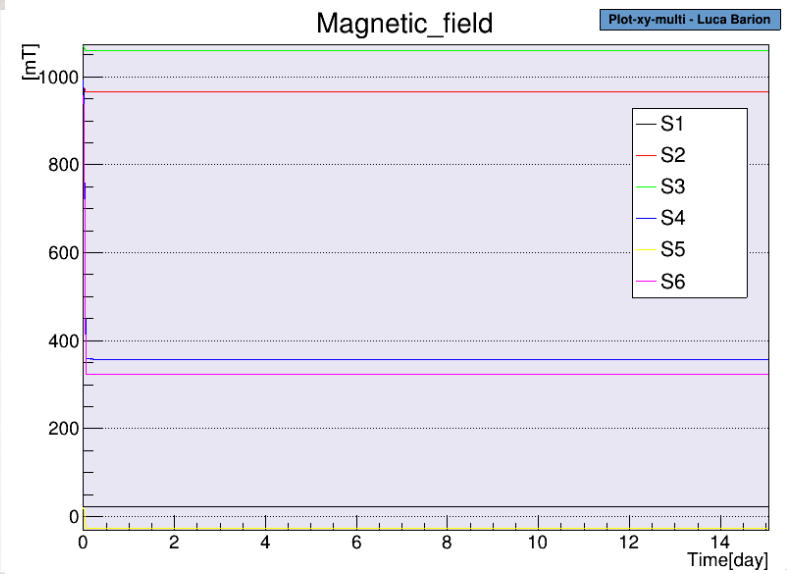

Shielding, 2024-03-18

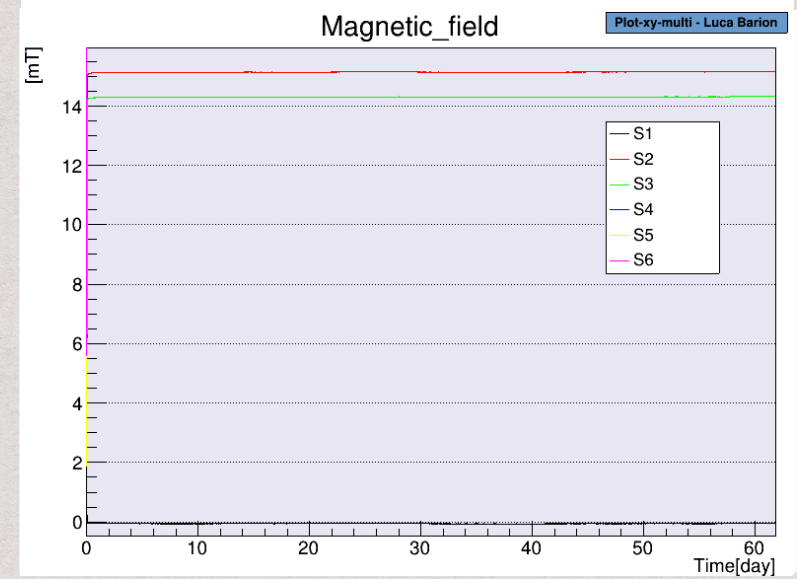

HDice did not meet RGH specifications

Most viable solution to prioritize physics vs R&D

Consolidated NH₃ technology

Designed based on already successful realizations

Hall-A G2p-Gep target (copy optimized for HTCC)

Hall-C E12-15-005 magnet (copy optimized for recoil detection)

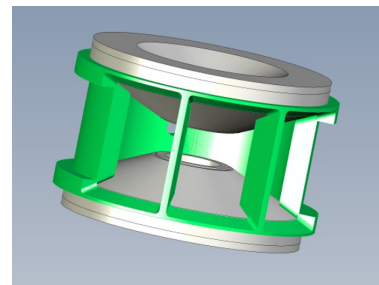

Acceptance:

$\pm 25^\circ$ horizontal

$\pm 60^\circ$ horizontal

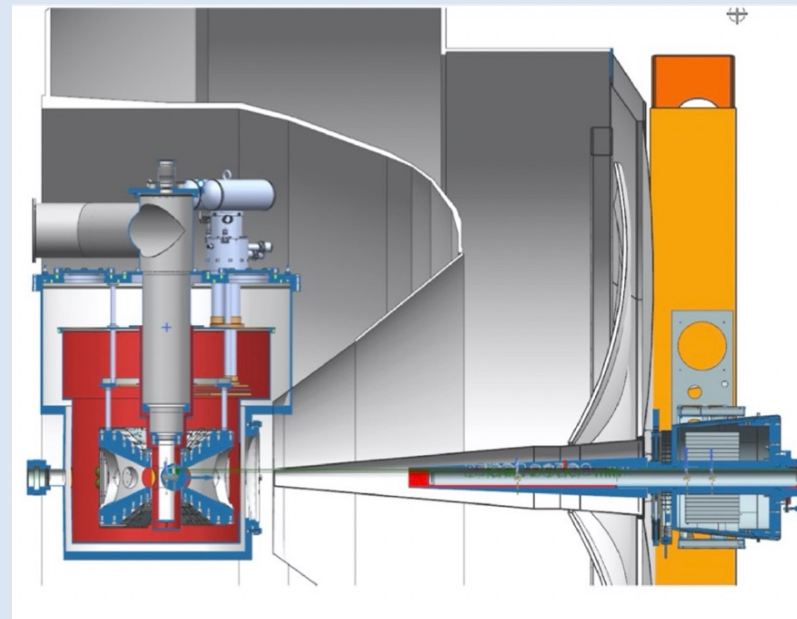
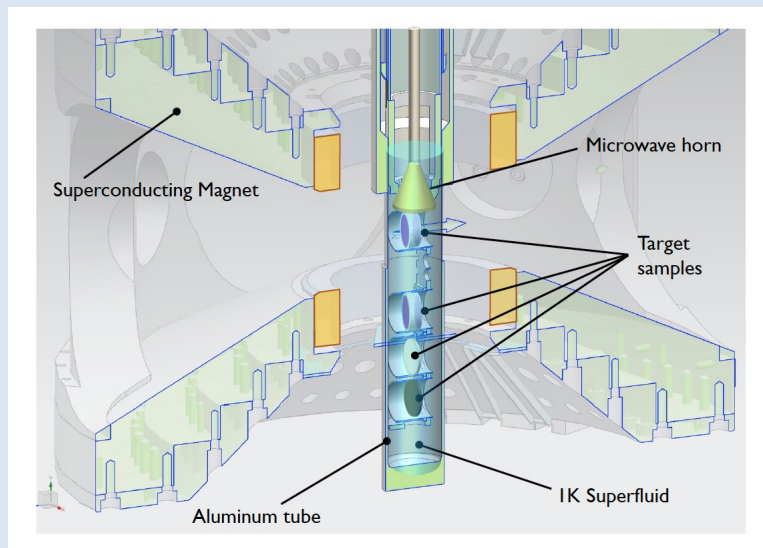

Based on
existing 0.7 mm raster
commercial 7.5T magnets

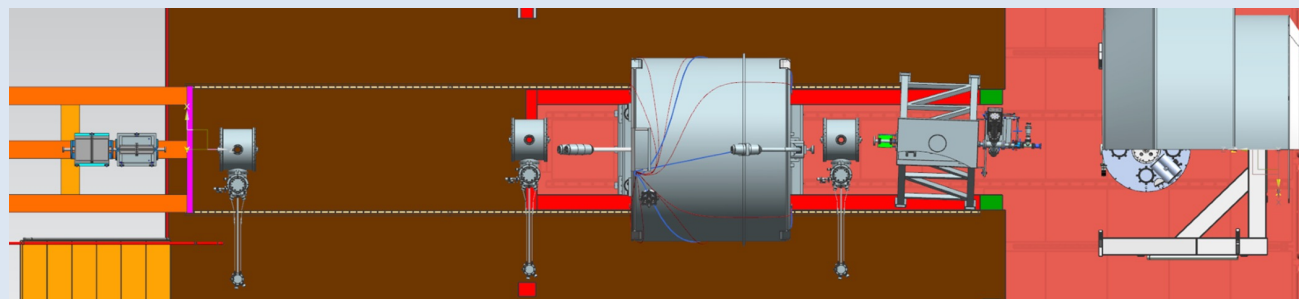
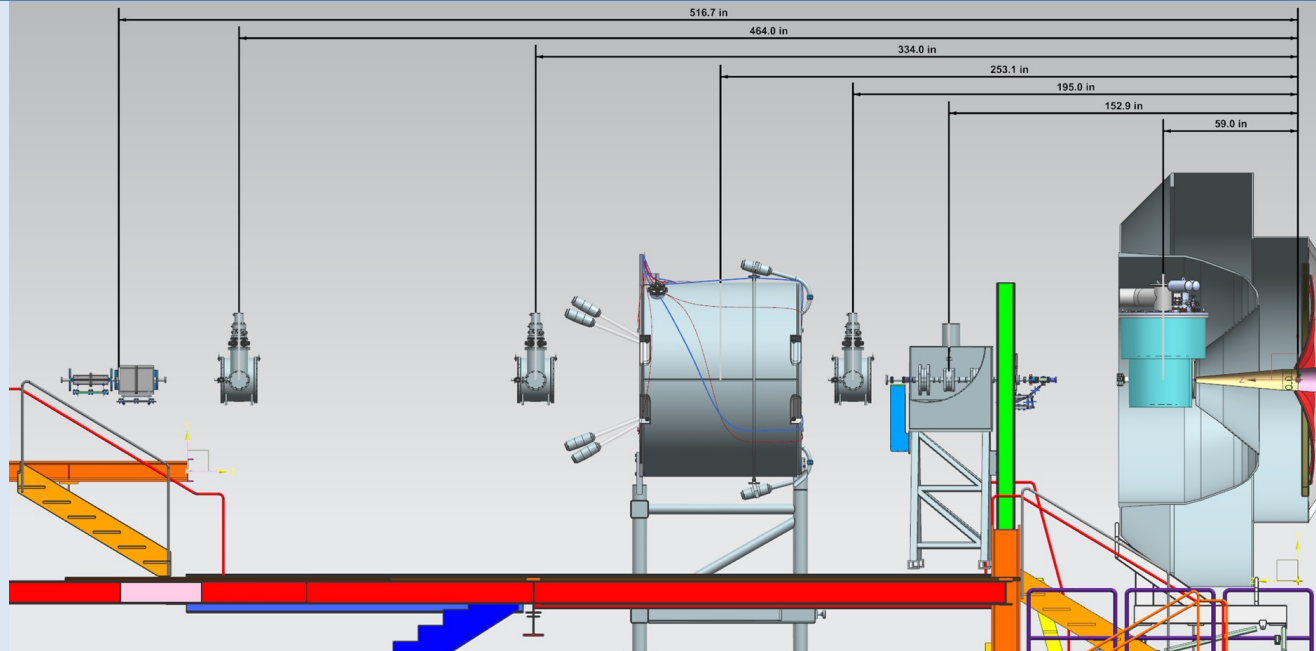
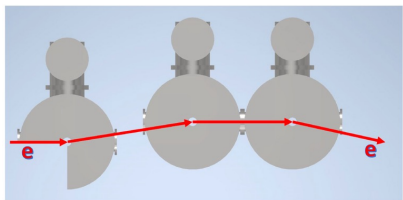

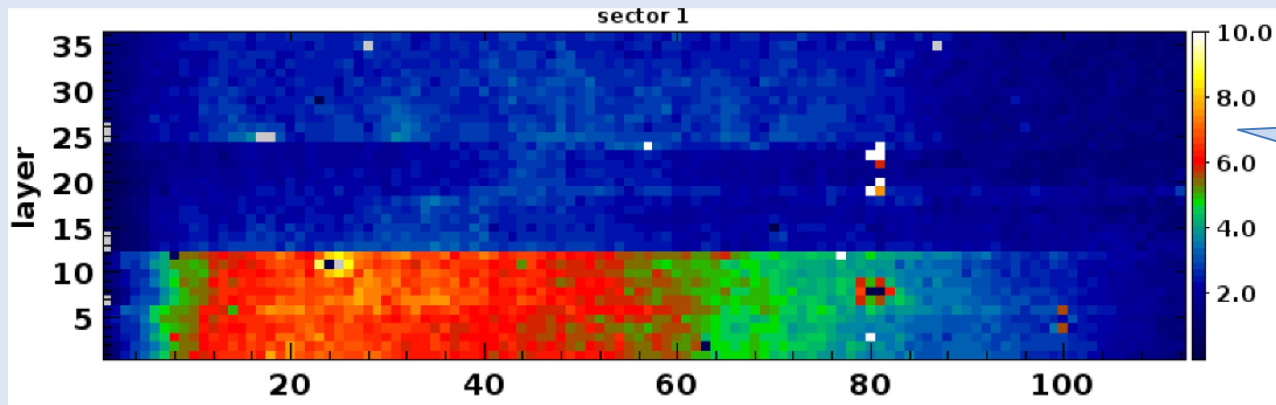

RGC DATA

Present performance*

Typical DC occupancy
measured at CLAS12

*No high-lumi

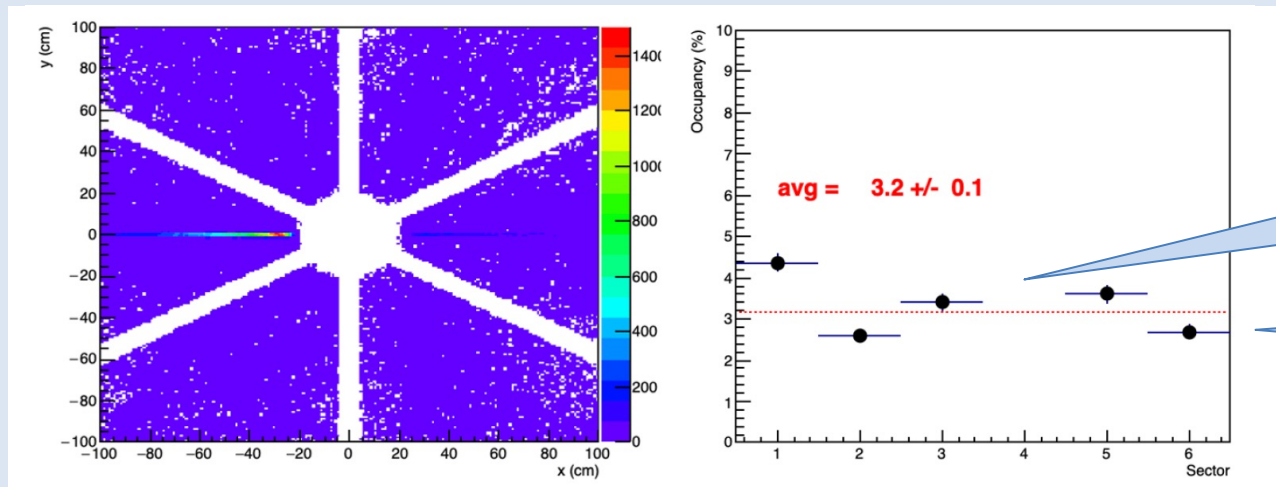

RGH MC

Assume to switch
OFF DC in sector 4
RICH in sector 3

x2 with
CLAS12 gate

RGH solution is most viable (no R&D) and superior to the conditionally approved one by PAC

PAC stipulated
conditions
for approval

Quantity	HD	NH ₃
$(1-\tau)$	0.96	0.97
f	1/3	3/17
P	0.41	0.85
I (nA)	1.0	2.0
ρ (g/cc)	0.10	0.87
x (cm)	5.0	1.0
$\mathcal{L} \times 10^{33}$	2.5	5.0
FoM $\times 10^{32}$	0.4	1.1

Conservative estimate

Existing or commercial magnets

Consolidated target technology

Target design already in use at JLab

Current CLAS tracking capability

Better than approved FoM (forward phase-space is basically untouched)

Example 1: π^0 provides clean probe
minor VM and γ_L contribution

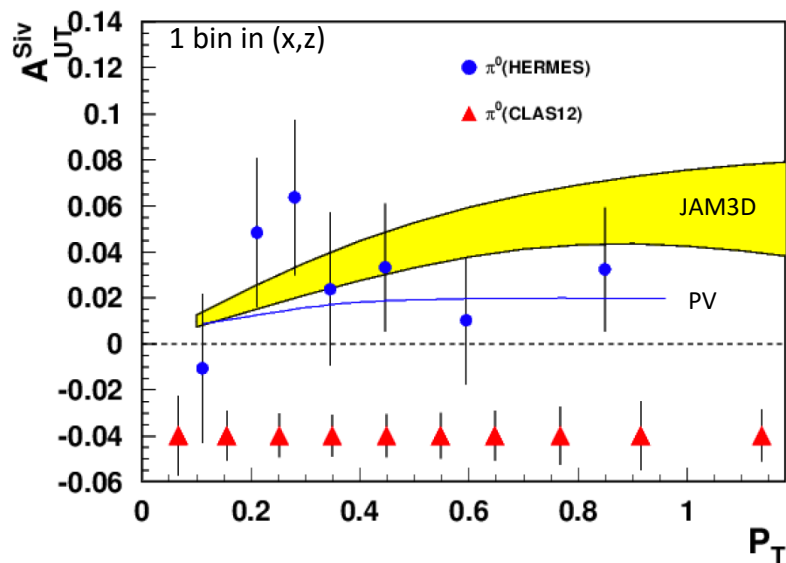

Example 2: di-hadron provides collinear benchmark
validation of TMD formalism

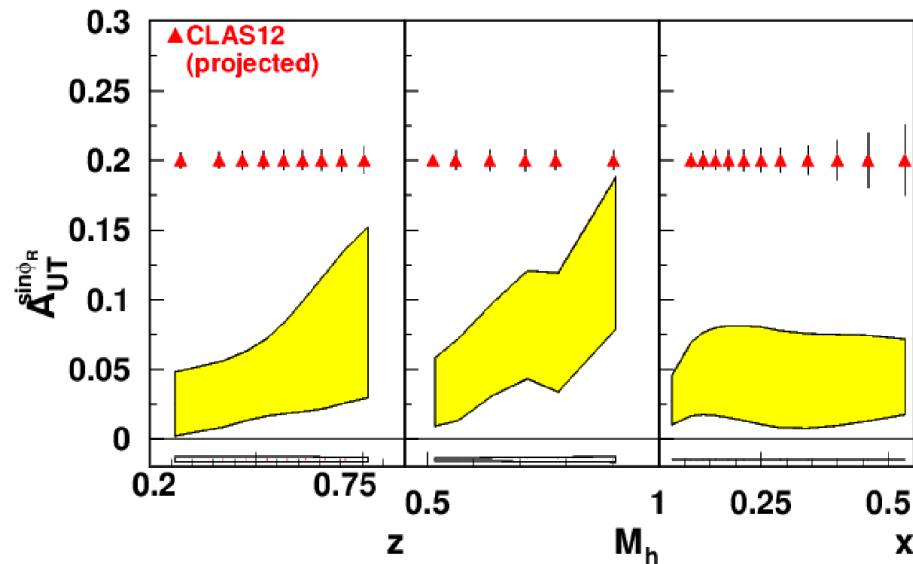

Simulated RGH recoil resolution
 based on ongoing tech. development
 and CLAS12 FD tracking resolution

Recoil concept

$\sigma_{x,y}$ O(100 μm)
 σ_t O(100 ps)

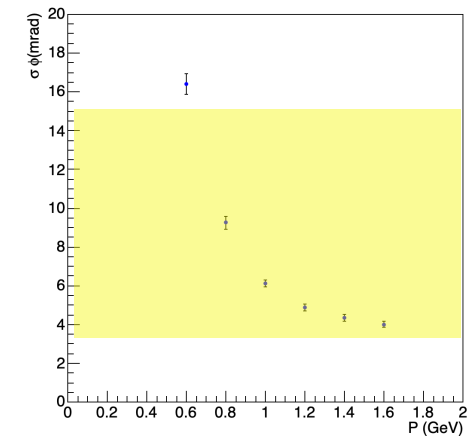
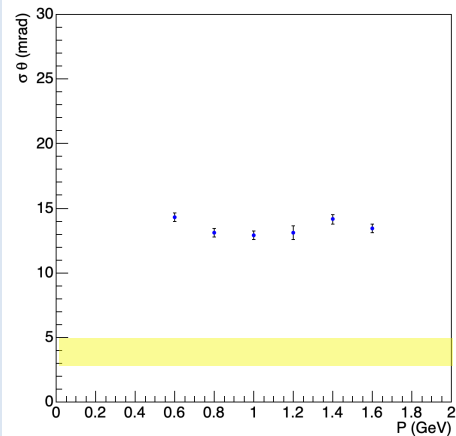
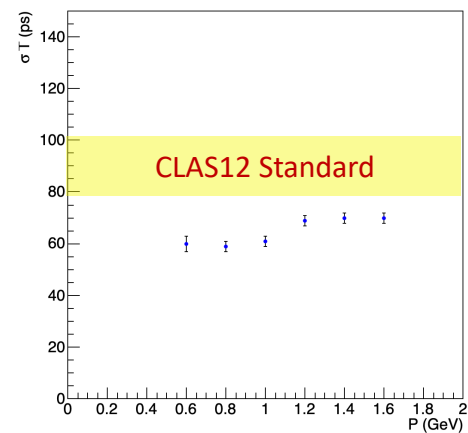
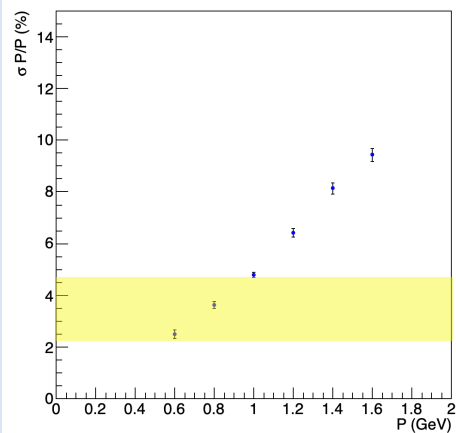
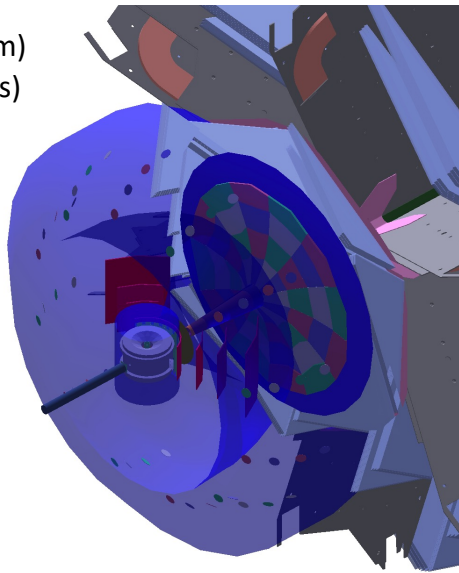

Spatial resolution $O(100 \mu\text{m})$ with μ -Rwell technology under development for the CLAS12 high-lumi project

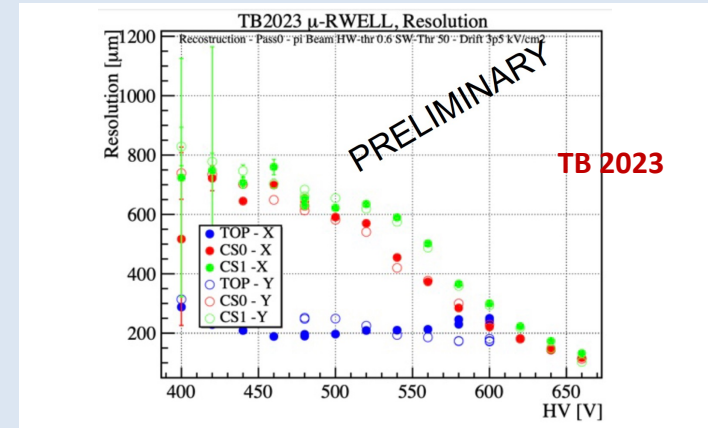
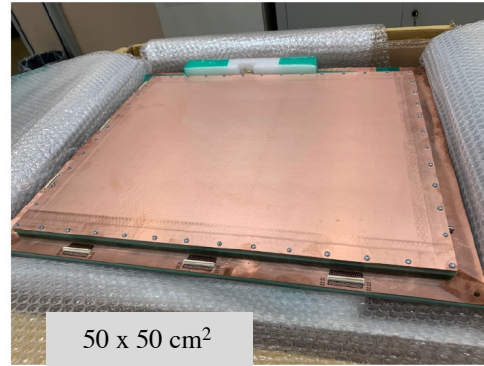
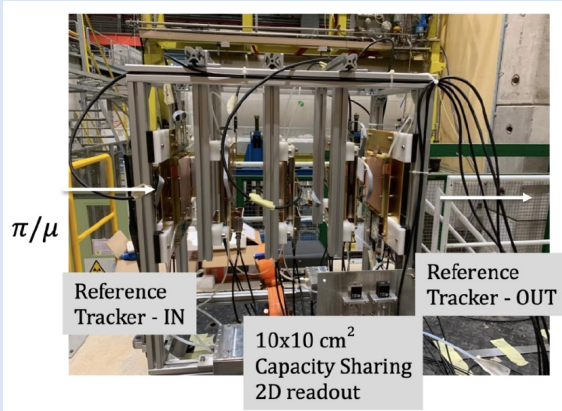

Time resolution $O(100 \text{ ps})$ with scintillating fiber tagger in synergy with other (EIC) projects

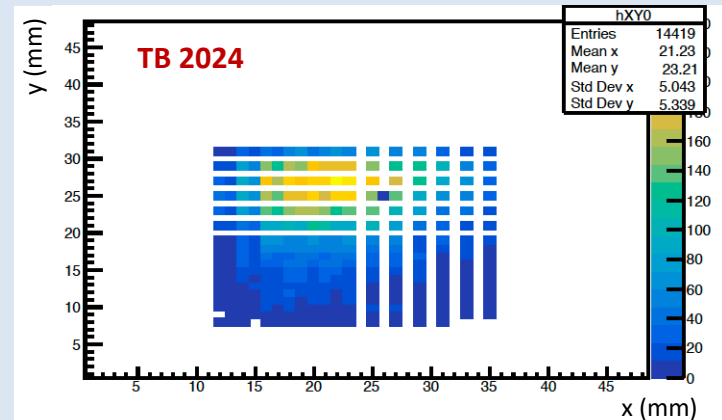
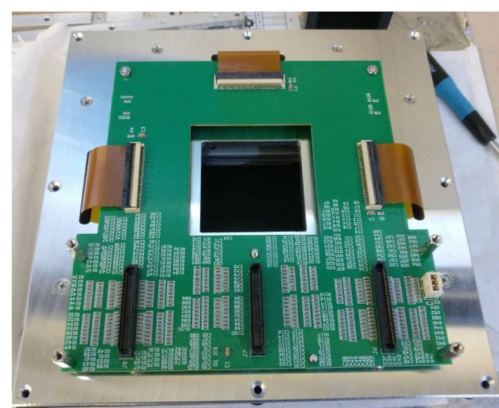
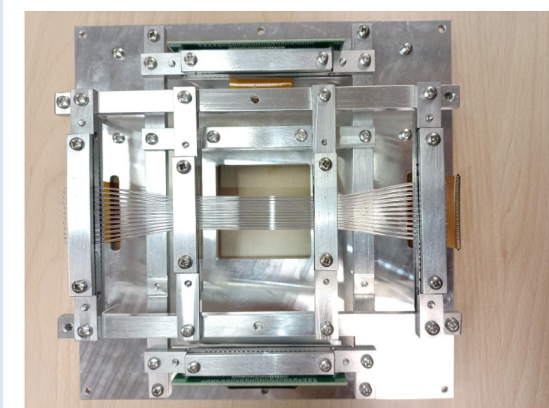

Spatial resolution $O(100 \mu\text{m})$ with μ -Rwell technology under development for the CLAS12 high-lumi project

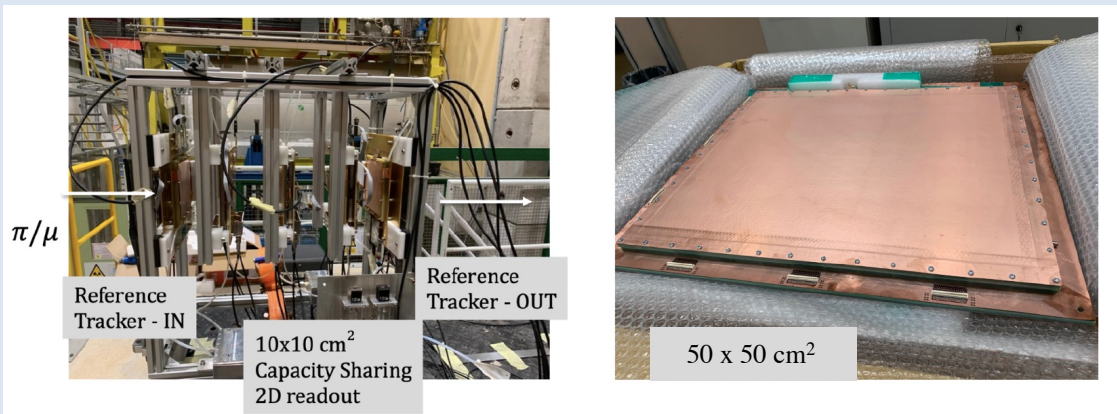

2D readout R&D ongoing within CLAS12 high-lumi

Large prototype dimensions already compatible

Readout from SBS GEM

Time resolution $O(100 \text{ ps})$ with scintillating fiber tagger in synergy with other (EIC) projects

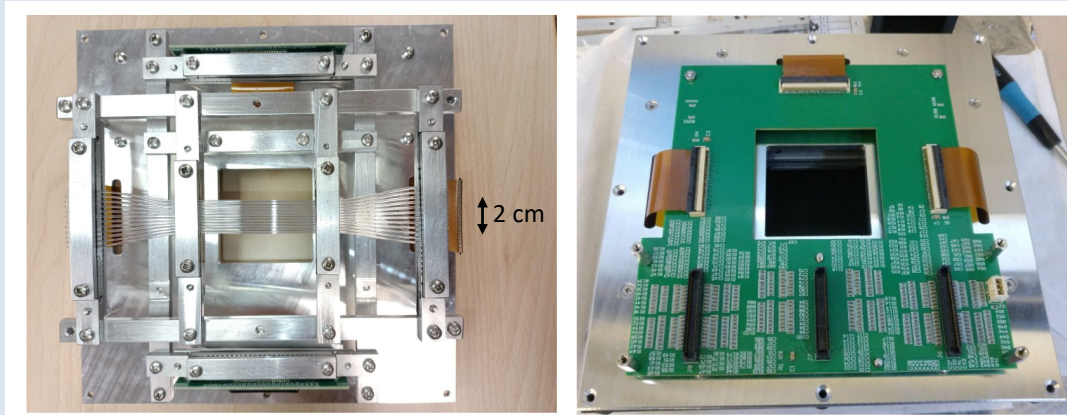

R&D in synergy with ePIC dRICH (prototype tracking / tagger)

Funds requested for test-readout based on SiPM/MAROC/ALCOR $O(10 \text{ keu})$

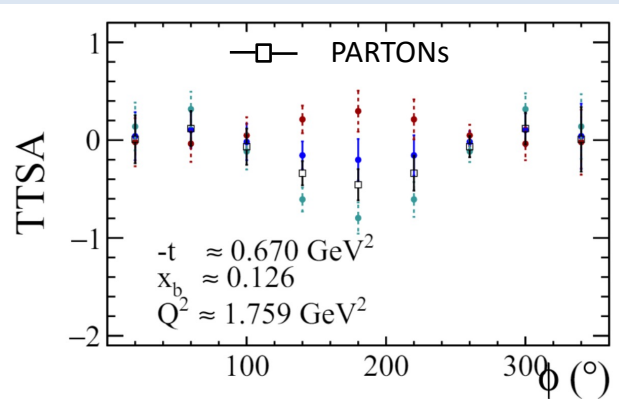

Superior discrimination power between various OAM model hypotheses

- $J_u = 0.5, J_d = 0.1$
- $J_u = -0.5, J_d = -0.1$
- $J_u = 0.2, J_d = 0.0$

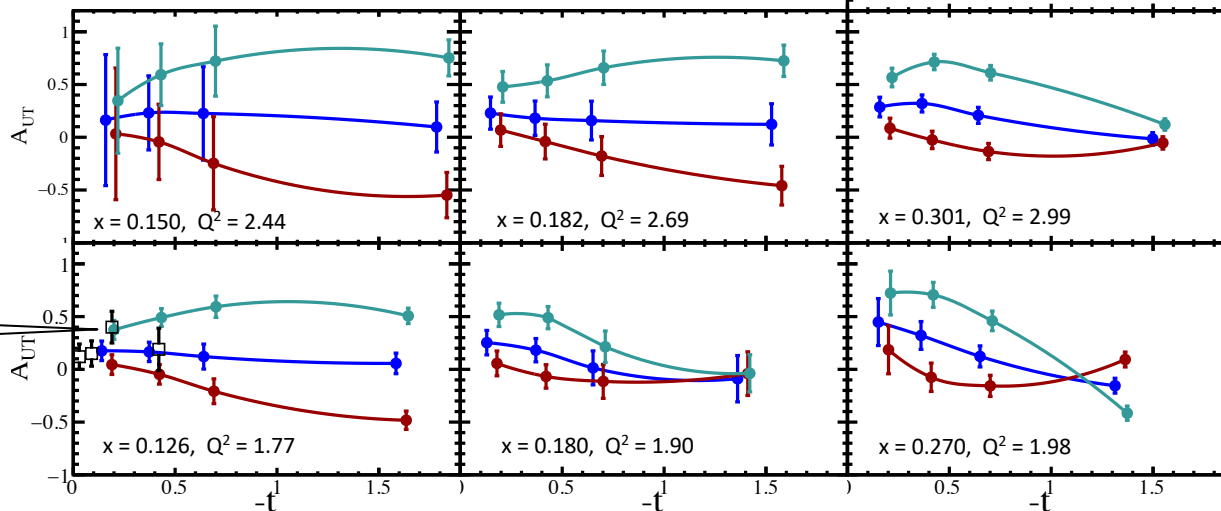
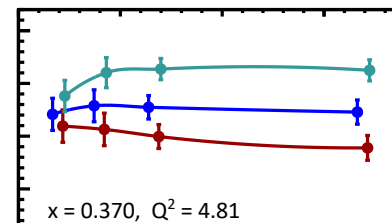

HERMES

RGH team is working hard to make high impact RGH experiments a reality

Experiment	Contact	Title	Rating	PAC days
C12-11-111	M. Contalbrigo	Transverse spin effect in SIDIS at 11 GeV with a transversely polarized target using CLAS12	A	110
C12-12-009	H. Avakian	Measurement of transversity with di-hadron production in SIDIS with a transversely polarized target	A	110
C12-12-010	L. Elauadrhiri	Deeply Virtual Compton scattering at 11 GeV with transversely polarized target using the CLAS12 detector	A	110

Important progresses since the original approval:

Science: paramount case with novel lattice inputs but awaiting data

CLAS12: up and running, completed with RICH, ideal for SIDIS and exclusive channels

Target: viable solution better than the PAC condition for approval

2025: study of the target configuration and synergetic R&D on recoil detector solutions